

8 Surface Integrals

8.1 Surfaces

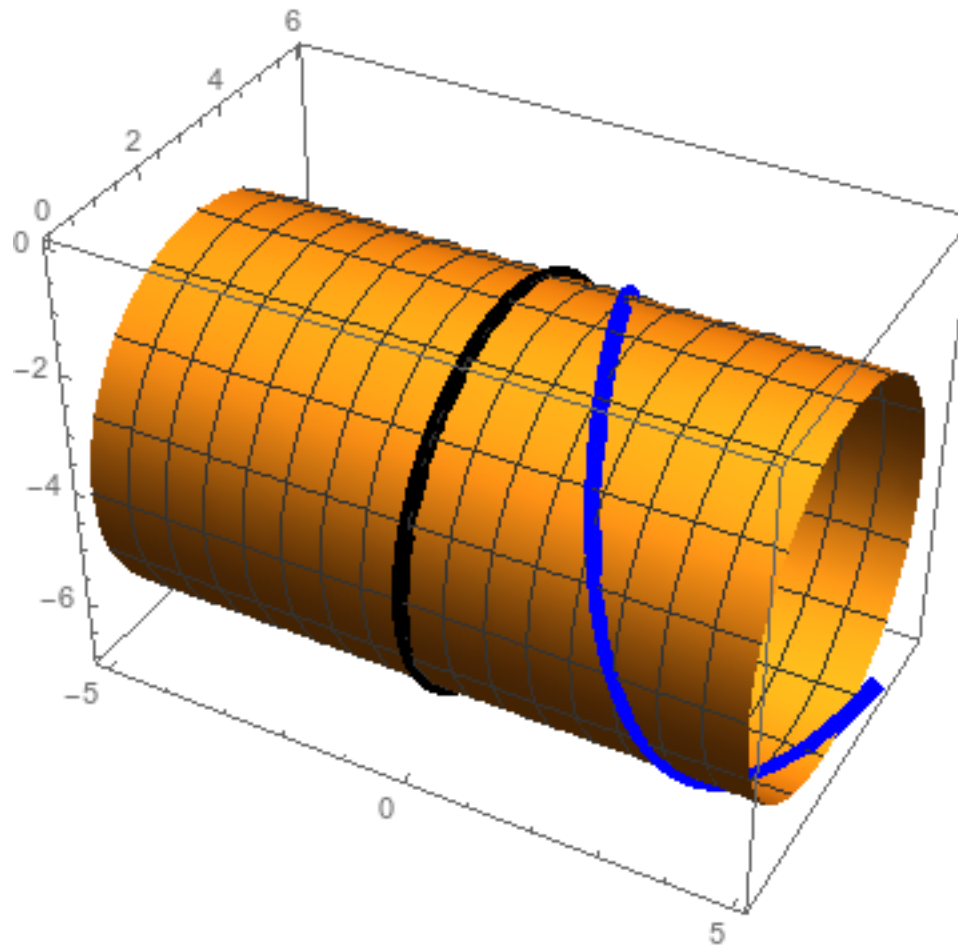

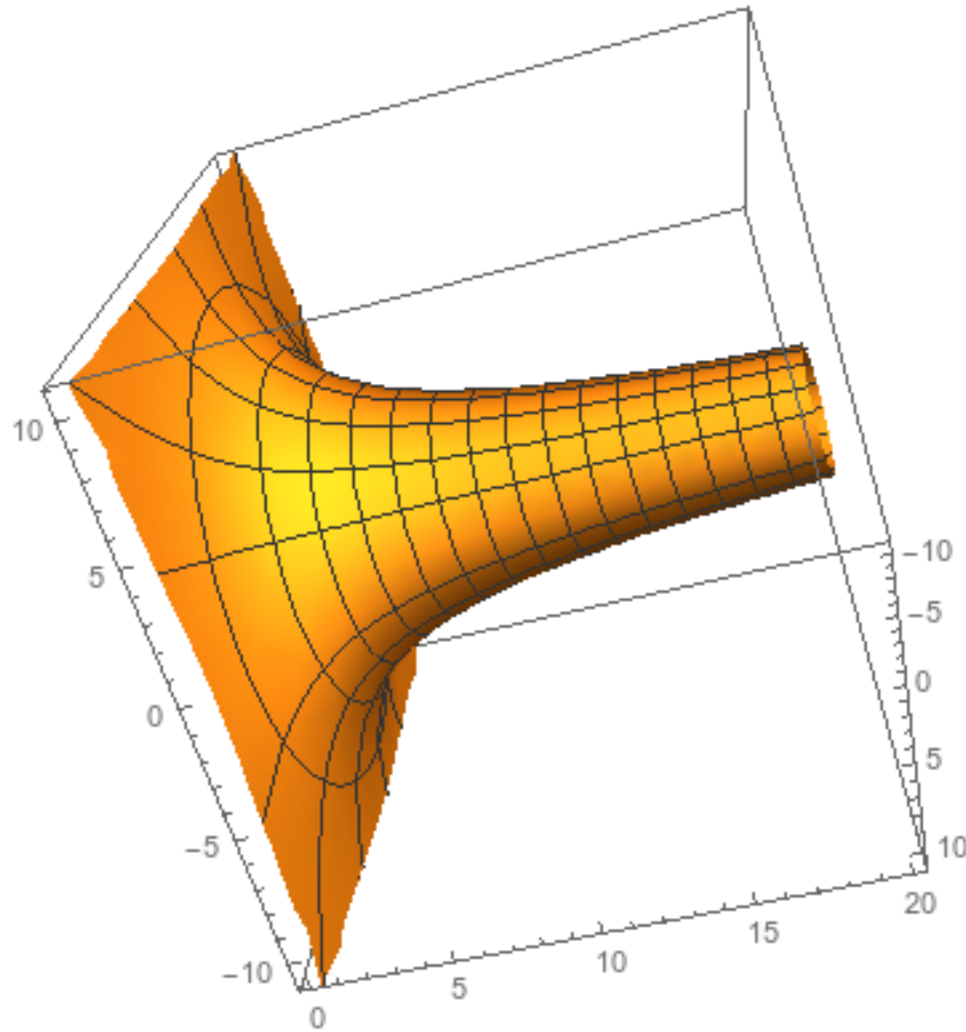

8.2 Scalar Surface Integrals

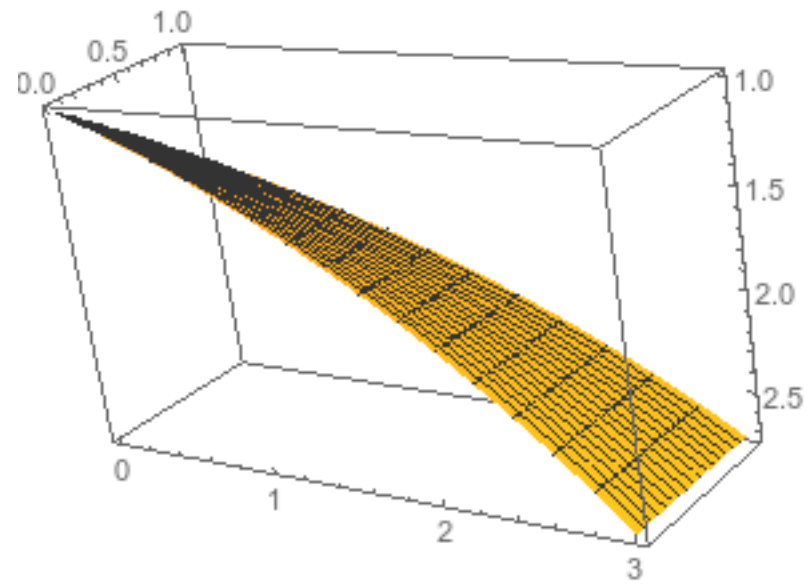

8.3 Flux Integrals

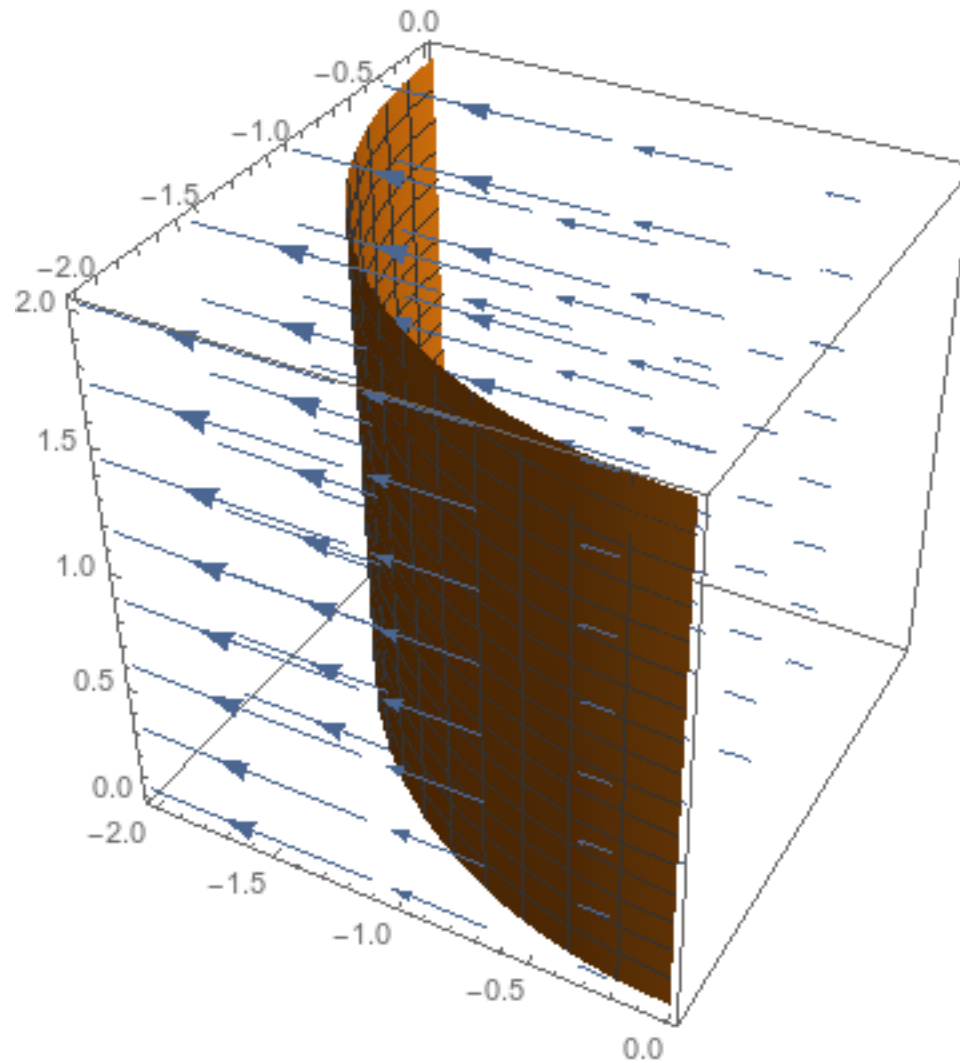

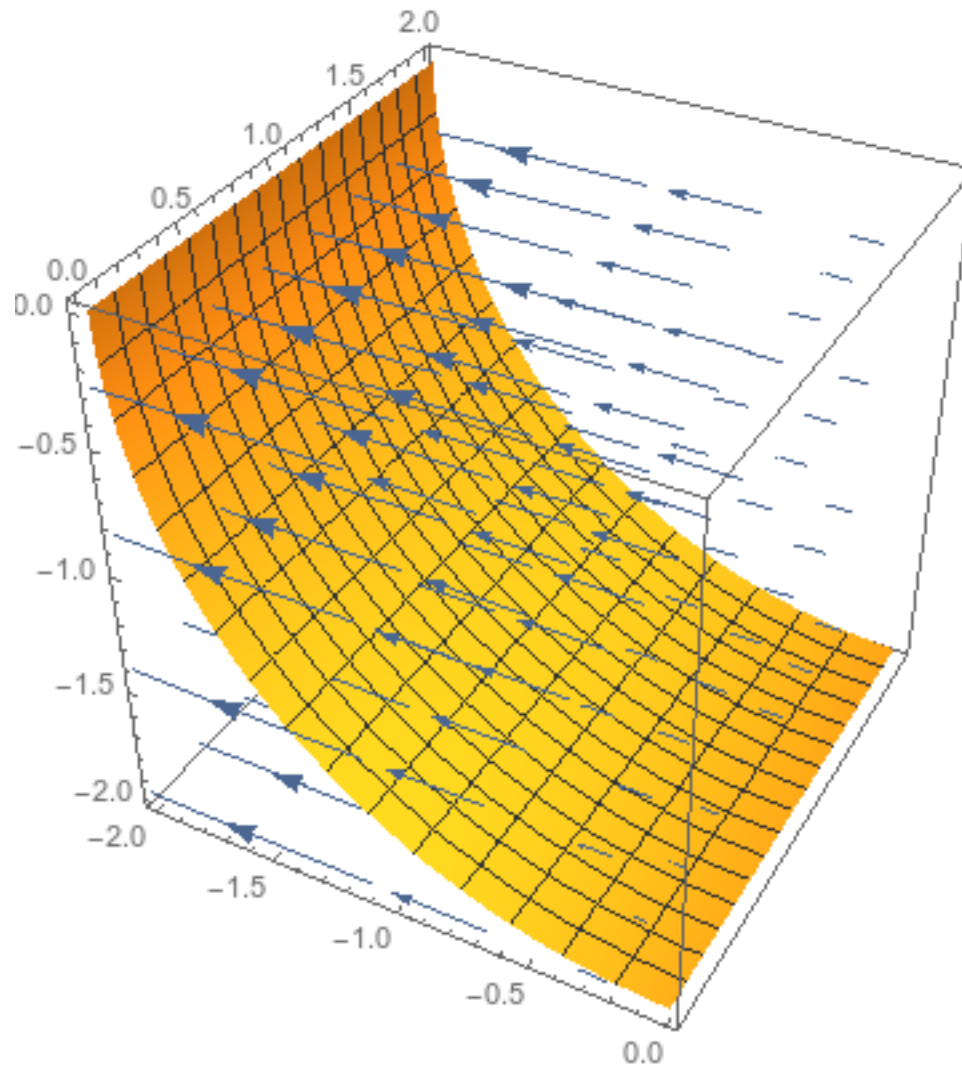

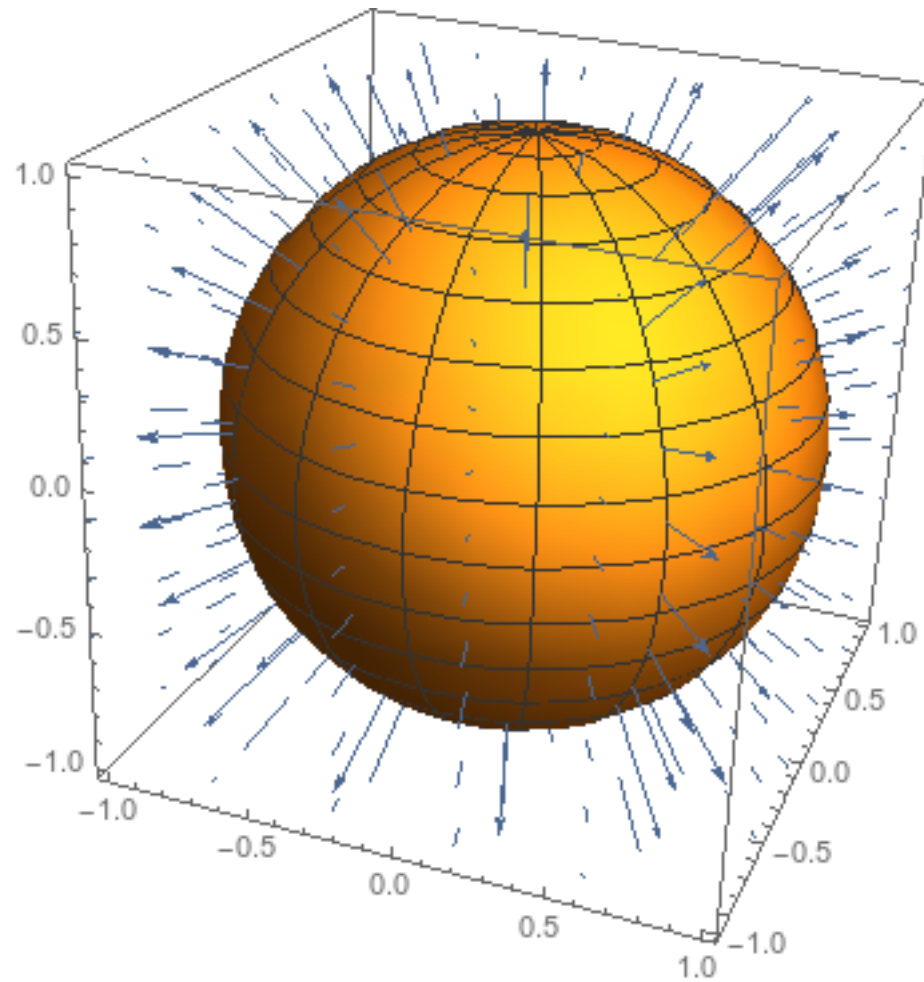

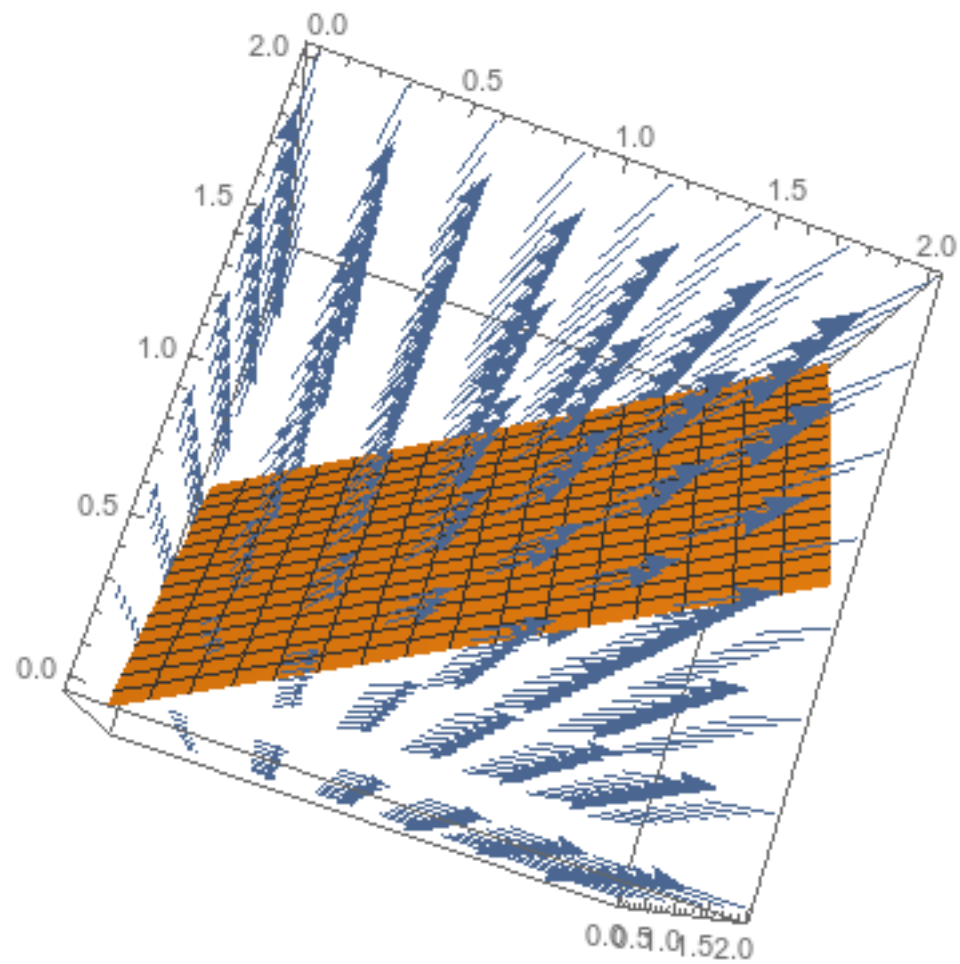

8.4 Stokes's Theorem

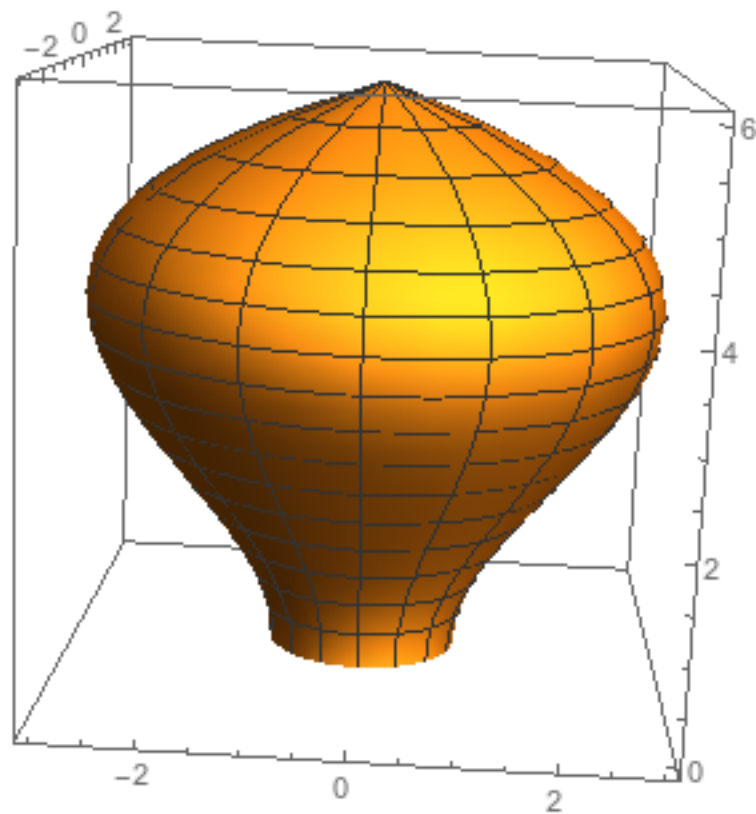

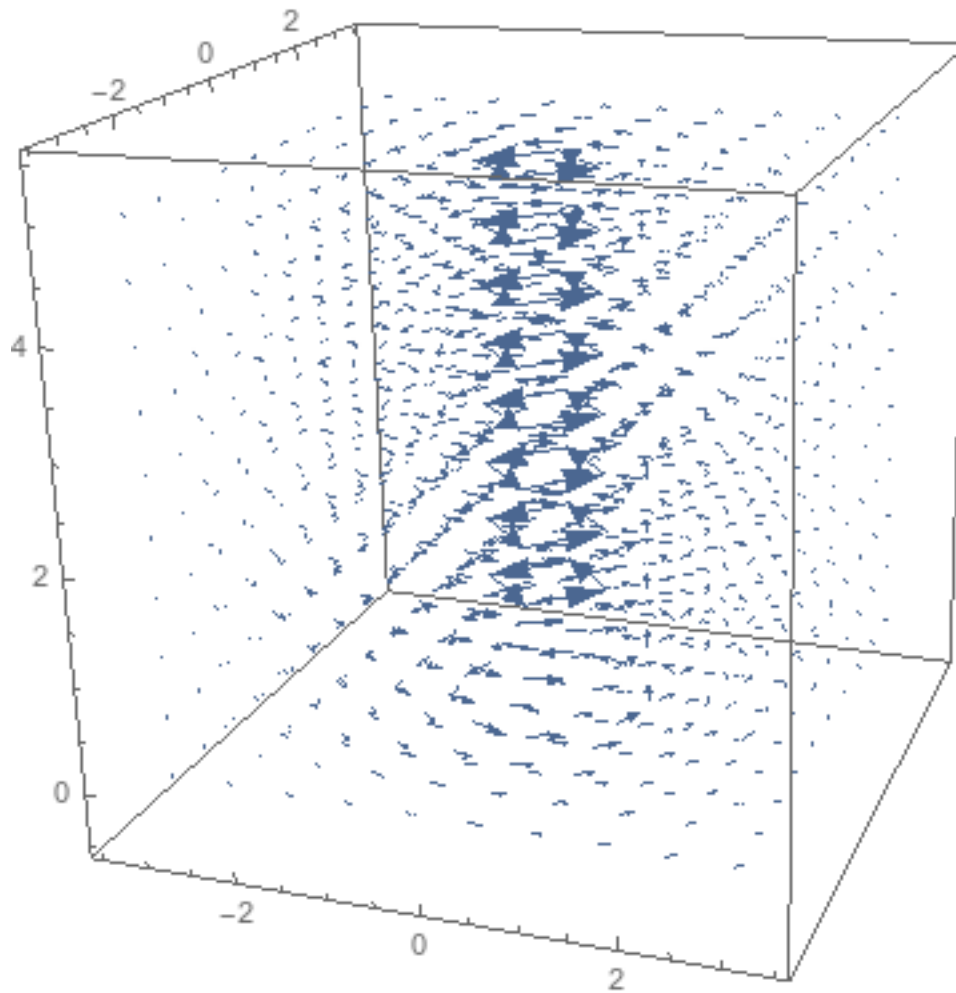

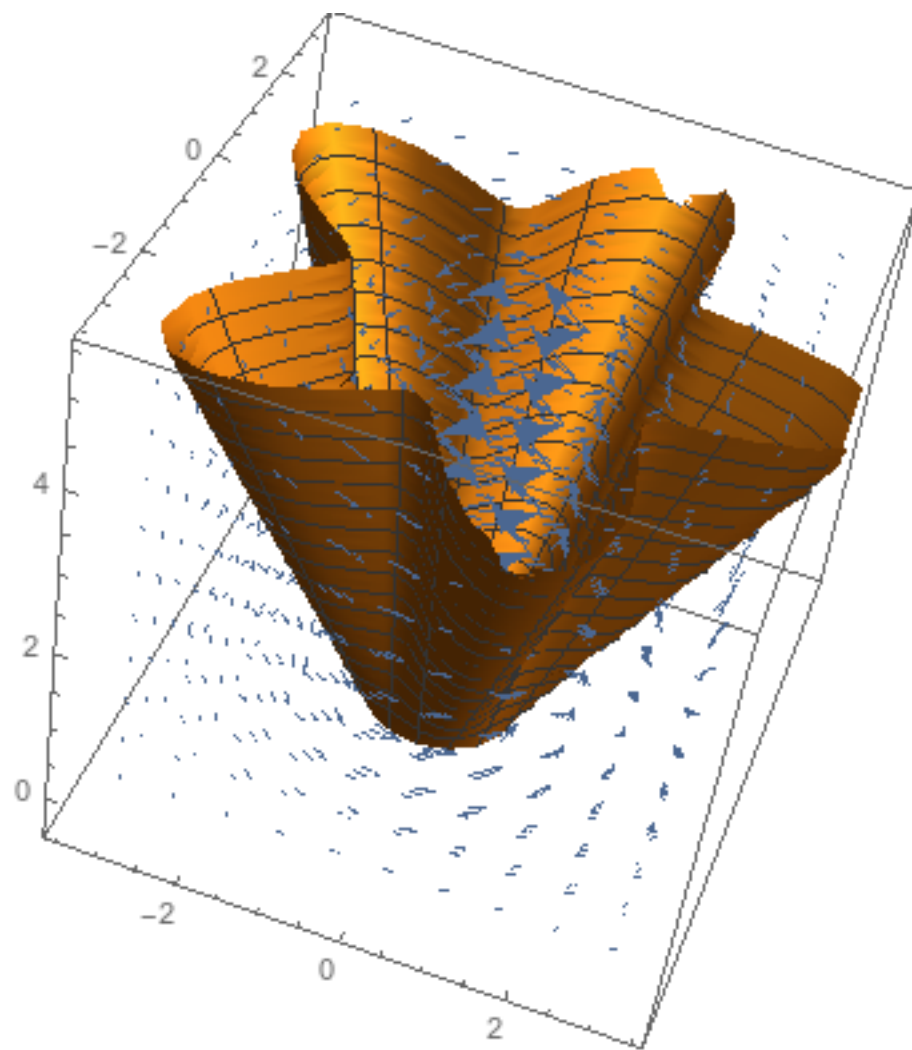

9 Divergence

9.1 The divergence of a vector field

